

**TESTING FOR THE VERIFICATION OF COMPLIANCE OF PV
INVERTER WITH:**

**IEC 60068-2-1, Environmental Testing. Part 2-1:
Tests. Test Ae: Cold.**

**IEC 60068-2-2, Environmental Testing. Part 2-2:
Tests. Test Be: Dry heat.**

**IEC 60068-2-14, Environmental Testing. Part 2-14:
Tests. Test Nb: Change of temperature.**

**IEC 60068-2-30, Environmental Testing. Part 2-30:
Tests. Test Db-Variant 1: Damp heat, cyclic (12 h + 12 h cycle).**

Procedure: PE.T-LE-62

Test Report Number: 2219 / 0190-4-M1

Trademark:



Tested Model.....: **EVVO 15000TLG23P**

Variant Models: **EVVO 15000TLG23P, EVVO 12000TLG23P,
EVVO 10000TLG23P**

APPLICANT

Name: **EVOLVE ENERGY GROUP CO., LIMITED**

Address: **RM 702, 7/F FU FAI COMM CTR 27 HILLIER ST SHEUNG
WAN, HK**

TESTING LABORATORY

Name: **SGS Tecnos, S. A. (Electrical Testing Laboratory)**

Address: **C/ Trespaderne, 29 - Edificio Barajas 1
28042 MADRID (Spain)**

Conducted (tested) by: **Hugo Zhang**

(Project Engineer)

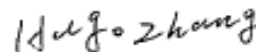

Roger Hu

(Project Engineer)



Approved by: **Jacobo Tevar**

(Technical Reviewer)

Date of issue.....: **17/10/2019**

Number of pages: **29**

Important Note:

- This document is issued by the Company subject to its General Conditions of Service printed overleaf, available on request or accessible at www.sgs.com/terms_and_conditions.htm and, for electronic format documents, subject to Terms and Conditions for Electronic Documents at www.sgs.com/terms_e-document.htm. Attention is drawn to the limitation of liability, indemnification and jurisdiction issues defined therein. Any holder of this document is advised that information contained hereon reflects the Company's findings at the time of its intervention only and within the limits of Client's instructions, if any. The Company's sole responsibility is to its Client and this document does not exonerate parties to a transaction from exercising all their rights and obligations under the transaction documents.
- This document cannot be reproduced except in full, without prior written approval of the Company. Any unauthorized alteration, forgery or falsification of the content or appearance of this document is unlawful and offenders may be prosecuted to the fullest extent of the law. Unless otherwise stated the results shown in this test report refer only to the sample(s) tested.

Test Report Historical Revision:

Test Report Version	Date	Resume
2219 / 0190-4	19/06/2019	First issuance
2219 / 0190-4-M1	17/10/2019	This report is a first issuance for a co-license based on report number 2219 / 0190-4

INDEX

1	SCOPE	4
2	GENERAL INFORMATION.....	5
2.1	Testing Period and Climatic conditions	5
2.2	Equipment under Testing	5
2.3	Test equipment list	8
2.4	Measurement uncertainty.....	8
2.5	Test set up of the different standard	9
2.6	Definitions.....	10
3	RESUME OF TEST RESULTS.....	11
4	TEST RESULTS	12
4.1	Test Ae: Cold.....	12
4.2	Test Be: Dry heat	13
4.3	Test Nb: Change of temperature.....	14
4.4	Test Db: Damp heat, Cyclic (12 h + 12 h).....	16
5	PICTURES.....	18
6	ELECTRICAL SCHEMES.....	29

1 SCOPE

SGS Tecnos, S.A. (Electrical Testing Laboratory) has been contract by Shenzhen SOFAR SOLAR Co., Ltd., in order to perform the testing according to the following Standards:

- IEC 60068-2-1:2007, Environmental Testing. Part 2-1: Tests. Test Ae: Cold.
- IEC 60068-2-2:2007, Environmental Testing. Part 2-2: Tests. Test Be: Dry heat.
- IEC 60068-2-14:2009, Environmental Testing. Part 2-14: Tests. Test Nb: Changes of temperature.
- IEC 60068-2-30:2005, Environmental Testing. Part 2-30: Tests. Test Db – Variant 1: Damp heat, cyclic (12 h + 12 h).

2 GENERAL INFORMATION

2.1 Testing Period and Climatic conditions

The necessary testing has been performed along between the 29th of May and 11th of Jun of 2019. Laboratory ambient temperature tests and checks have been performed at 25 ± 5°C, 96 kPa ± 10 kPa and 50% RH ± 10% RH.

SITE TEST

Name : Shenzhen SOFAR SOLAR Co., Ltd.
 Address : 401, Building 4, AnTongDa Industrial Park, District 68, XingDong Community, XinAn Street, BaoAn District, Shenzhen City, Guangdong Province, P.R. China

2.2 Equipment under Testing

Apparatus type : Solar Grid-tied Inverter
 Installation : Fixed(permanent connection)
 Manufacturer : EVOLVE ENERGY GROUP CO., LIMITED
 Trade mark : 
 Model / Type reference : **EVVO 15000TLG23P**
 Serial Number..... : SN1CS015K3G061
 Software Version : V0.21
 Rated Characteristics : DC input: 160V-960V Max.21A /11 A
 AC output: 3/N/PE 230/400Va.c, 50Hz, Max.3 x 24A, 15000W

Date of manufacturing: 2018

Test item particulars

Input..... : DC
 Output..... : AC
 Class of protection against electric shock ... : Class I
 Degree of protection against moisture : IP 65
 Type of connection to the main supply..... : TN
 Cooling group : Heat sink
 Modular..... : No
 Internal Transformer : No

Copy of marking plate(representative):

EVVO Solar Grid-tied Inverter	
Model No:	EVVO 15000TLG23P
Max.DC Input Voltage	1000V
Operating MPPT Voltage Range	160~960V
Max. Input Current	21A/11A
Max. PV Isc	30A/15A
Nominal Grid Voltage	3/N/PE,230/400Vac
Max.Output Current	3x24A
Nominal Grid Frequency	50/60Hz
Nominal Output Power	15000W
Max.Output Power	16500VA
Power Factor	>0.99(adjustable+/-0.8)
Ingress Protection	IP65
Operating Temperature Range	-25°C~ +60°C
Protective Class	Class I
Topology	Non-isolated
Made In China	
Manufacturer : EVOLVE ENERGY GROUP CO., LIMITED	
Address :RM 702, 7/F FU FAI COMM CTR 27 HILLIER ST SHEUNG WAN, HK	
Global Head Quarters	
371 Sidco Industrial Estate	
Chennai 600098 India	
IEC62109-1,IEC62109-2,NB-T 32004	

Note:

1. The above markings are the minimum requirements required by the safety standard. For the final production samples, the additional markings which do not give rise to misunderstanding may be added.
2. Label is attached on the side surface of enclosure and visible after installation
3. Labels of other models are as the same with **EVVO 15000TLG23P**'s except the parameters of rating.

Equipment Under Testing:

- **EVVO 15000TLG23P**

Variant models:

- **EVVO 12000TLG23P**
- **EVVO 10000TLG23P**

Model Number	EVVO 15000TLG23P	EVVO 12000TLG23P	EVVO 10000TLG23P
Max. input voltage	1000Vd.c.		
Max. input current	21A/11A		
Operating MPPT voltage range	160V-960V		
Rated voltage	600V		
Full load DC Voltage Range	500V-850V	500V-850V	350V-850V
Rated grid voltage	3/N/PE 230/400Va.c		
Rated grid frequency	50Hz		
Rated output power	15000W	12000W	10000W
Max. output current	3 x 24A	3 x 20A	3 x 16.5A
Power factor	0.8 leading to 0.8 lagging		
Ambient temperature	-25 °C ~60 °C		
Ingress protection	IP65		
Protective class	Class I		

The variants models have been included in this test report without tests because the following features don't change regarding to the tested model:

- Same connection system and hardware topology
- Same control algorithm.
- Output power within 2.5 and 2/3 of the EUT or Modular inverters.
- Same Firmware Version

The results obtained apply only to the particular sample tested that is the subject of the present test report. The most unfavorable result values of the verifications and tests performed are contained herein.

Throughout this report a point (comma) is used as the decimal separator

2.3 Test equipment list

From	No.	Equipment Name	Model No.	Equipment No.	Calibration Date	Equipment calibration due date
Sofarsolar	1	Digital oscilloscope	DS05014A	MY500702 66	2019-02-13	2020-02-12
	2	Voltage probe	SI-9110	111541	2019-02-13	2020-02-12
	3	Voltage probe	SI-9110	152627	2019-02-13	2020-02-12
	4	Voltage probe	SI-9110	111134	2019-02-13	2020-02-12
	5	Voltage probe	SI-9110	111539	2019-02-13	2020-02-12
	6	Power analyzer	WT3000	91N610888	2019-02-13	2020-02-12
	7	Current probe	i1000S	29503223	2019-02-13	2020-02-12
	8	Current probe	i1000S	30413448	2019-02-13	2020-02-12
	9	Current probe	i1000S	30413441	2019-02-13	2020-02-12
	10	Current probe	CP5150	C15015000 8	2019-02-13	2020-02-12
	11	Current probe	CP1000A	C18100092 7	2019-02-13	2020-02-12
	12	Current probe	CP1000A	C18100092 6	2019-02-13	2020-02-12
	13	Temperature & Humidity meter	TH101B	201030245 220	2019-02-13	2020-02-12
	14	Temperature & Humidity Chamber	HGTP-225R	HG130308 01	2019-02-13	2020-02-12
SGS	15	True RMS Multimeter	Fluke / 289C	GZE012-53	2019-02-26	2020-02-25

2.4 Measurement uncertainty

Associated uncertainties through measurements showed in this this report are the maximum allowable uncertainties.

Magnitude	Uncertainty
Voltage measurement uncertainty	±1.5 %
Current measurement uncertainty	±2.0 %
Frequency measurement uncertainty	±0.2 %
Time measurement uncertainty	±0.2 %
Power measurement uncertainty	±2.5 %
Phase Angle	±1%
Temperature	±3° C
Note1: Measurements uncertainties showed in this table are maximum allowable uncertainties. The measurement uncertainties associated with other parameters measured during the tests are in the laboratory at disposal of the solicitant.	

2.5 Test set up of the different standard

The test bench used includes:

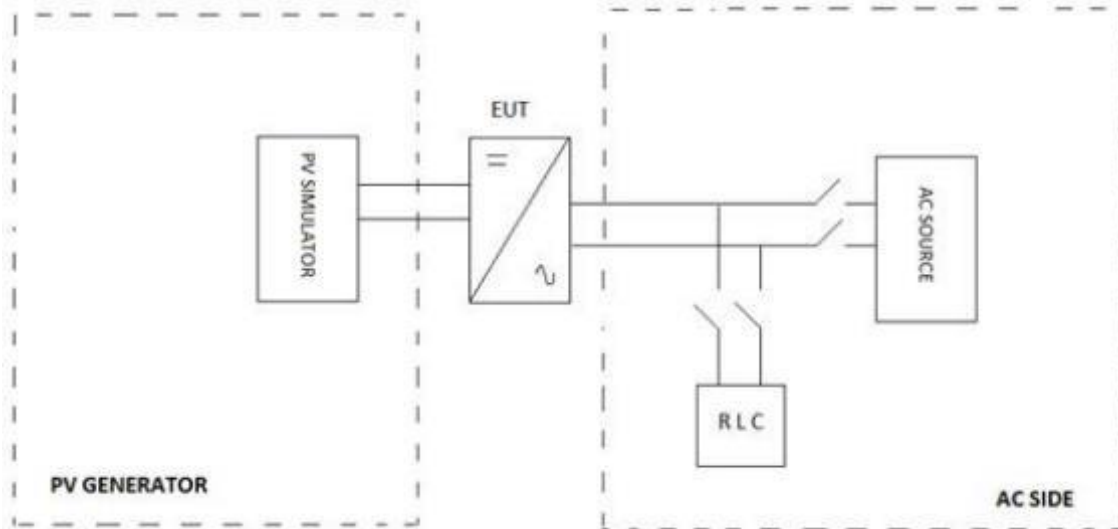

Different equipment has been used to take measures as it shows in chapter 2.3. Current and voltage clamps have been connected to the inverter output for all the tests.

All the tests described in the following pages have used this specified test setup.

2.6 Definitions

EUT	Equipment Under Testing	Hz	Hertz
A	Ampere	V	Volt
VA _r	Volt-Ampere reactive	W	Watt
U _n	Nominal Voltage	p.u	Per unit
I _n	Nominal Current	P _n	Nominal Active Power
I _a	Active Current	Q _n	Nominal Reactive Power
I _r	Reactive Current	S _n	Nominal Apparent Power
MV	Medium Voltage	°C	Celsius degree
LV	Low Voltage	K	Kelvin degree
RH	Relative Humidity		

3 RESUME OF TEST RESULTS

INTERPRETATION KEYS

- Test object does meet the requirement..... **P** Pass
- Test object does not meet the requirement..... **F** Fails
- Test case does not apply to the test object..... **N/A** Not applicable
- To make a reference to a table or an annex. See additional sheet
- To indicate that the test has not been realized **N/R** Not realized

TEST AND CHECKS			
Point	Standard	Test procedure	
4.1	IEC 60068-2-1	Test Ae: Cold	P
4.2	IEC 60068-2-2	Test Be: Dry heat.	P
4.3	IEC 60068-2-14	Test Nb: Change of temperature.	P
4.4	IEC 60068-2-30	Test Db: Damp heat, cyclic	P

Note: The declaration of conformity has been evaluated taking account the IEC Guide 115.

4 TEST RESULTS

4.1 TEST AE: COLD

The test purpose is the determination of the aptitude of the components, equipment and other items for use, transport or store at low temperature, according to the standard IEC 60068-2-1. Environmental testing. Part 2-1: Test. Test A: Cold.

Due to the nature of EUT, the applicable Test is Ae: This procedure is applied to specimens heat dissipative which are subjected to low temperature during an enough period for the specimen to reach the thermal stability. The EUT is required to be operating during all test duration.

Test Severities

The specimen is introduced into the chamber which is at the temperature of the laboratory. The temperature is then adjusted to the temperature appropriate to the degree of severity, as specified in the relevant specification. After temperature stability of the test specimen has been reached, the specimen is exposed to these conditions for the specified duration. For specimens that are required to be operational (even though they do not meet the requirements of being heat dissipating), power shall then be applied to the specimen and a functional test is performed as necessary. A further period of stabilization may be necessary and the specimen shall then be exposed to the low temperature conditions for a duration as specified in the relevant specification. Specimens under test are normally in operating conditions.

Test condition:

Test Temperature: -25 °C

Test Duration : 16h

Test result:

Measurements Pre-functional test:

PV Input:		AC grid output (line to neutral):	
Voltage DC (V)	597.7	Voltage AC (V)	230.4
Current DC (A)	25.7	Current AC (A)	21.8
Power DC (W)	15332	Active Power AC (W)	15064

Measurements During the test:

PV Input:		AC grid output (line to neutral):	
Voltage DC (V)	597.6	Voltage AC (V)	230.4
Current DC (A)	25.7	Current AC (A)	21.8
Power DC (W)	15339	Active Power AC (W)	15058

Measurements Post-functional test:

PV Input:		AC grid output (line to neutral):	
Voltage DC (V)	597.1	Voltage AC (V)	230.4
Current DC (A)	25.7	Current AC (A)	21.8
Power DC (W)	15329	Active Power AC (W)	15056

After the test, the EUT can operation normally.

4.2 TEST BE: DRY HEAT

The test purpose is the determination of the aptitude of the components, equipment and other items for use, transport or storage at high temperature, according to the standard IEC 60068-2-2. Environmental testing. Part 2-2: Tests. Test B: Dry heat

Due to the nature of EUT applicable test Be: This procedure is applied to specimens heat dissipative which are subjected to high temperature during an enough period time for the specimen to reach the thermal stability. The EUT is required to be operating during all test duration.

Test Severities

The specimen is introduced into the chamber, which is at the temperature of the laboratory. The temperature is then adjusted to the temperature appropriate to the degree of severity as specified in the relevant specification. After temperature stability of the test specimen has been reached, the specimen is exposed to these conditions for the specified duration. For specimens that are required to be operational (even though they do not meet the requirements of being heat dissipating) power shall then be applied to the specimen and a functional test is performed as necessary. A further period of stabilization may be necessary and the specimen shall then be exposed to the high temperature conditions for a duration as specified in the relevant specification.

Specimens under test are normally in operating conditions.

Test condition:

Test Temperature: +60°C

Test Duration : 16h

Test result:

Measurements Pre-functional test:

PV Input:		AC grid output (line to neutral):	
Voltage DC (V)	597.0	Voltage AC (V)	230.0
Current DC (A)	25.7	Current AC (A)	21.8
Power DC (W)	15331	Active Power AC (W)	15039

Measurements During test:

PV Input:		AC grid output (line to neutral):	
Voltage DC (V)	597.0	Voltage AC (V)	230.4
Current DC (A)	25.7	Current AC (A)	21.8
Power DC (W)	15330	Active Power AC (W)	15056

Measurements Post-functional test:

PV Input:		AC grid output (line to neutral):	
Voltage DC (V)	597.1	Voltage AC (V)	230.4
Current DC (A)	25.7	Current AC (A)	21.8
Power DC (W)	15330	Active Power AC (W)	15056

After the test, the EUT can operation normally.

4.3 TEST NB: CHANGE OF TEMPERATURE

This test includes alternating periods of high and low temperature with a good definition of transference between both temperatures. The test has been performed according to the standard IEC 60068-2-14. Environmental testing. Part 2-14: Tests. Test N: Change of temperature.

The inverter has been subjected to thermal changes according to the test Nb in order to evaluate the ability of components, equipment or other articles to withstand rapid changes of ambient temperature. With this method, variations of temperature are controlled with a specified speed of change.

The complete test performed includes:

1. Variation from standard atmospheric conditions to the temperature of conditioning "A".
2. Variation from temperature of conditioning "A" to temperature of conditioning "B".
3. Variation from temperature of conditioning "B" to temperature of conditioning "A".
4. Variation from temperature of conditioning "A" to temperature of conditioning "B".
5. Variation from the temperature of conditioning "B" to the ambient temperature of laboratory.

Test Severities

The severity of the test is defined by the combination of the two temperatures, the transfer time, the exposure time of the specimen and the number of cycles.

The lower temperature, T_A , shall be specified in the relevant specification and should be chosen from the test temperatures of IEC 60068-2-1 and IEC 60068-2-2.

The higher temperature, T_B , shall be specified in the relevant specification and should be chosen from the test temperatures of IEC 60068-2-1 and IEC 60068-2-2.

The exposure time, t_1 , of each of the two temperatures depends upon the heat capacity of the specimen. It may be 3 h, 2 h, 1 h, 30 min or 10 min, or as specified in the relevant specification. Where no exposure period is specified in the relevant specification, it is understood to be 3 h.

The preferred number of test cycles is five, unless otherwise specified in the relevant specification.

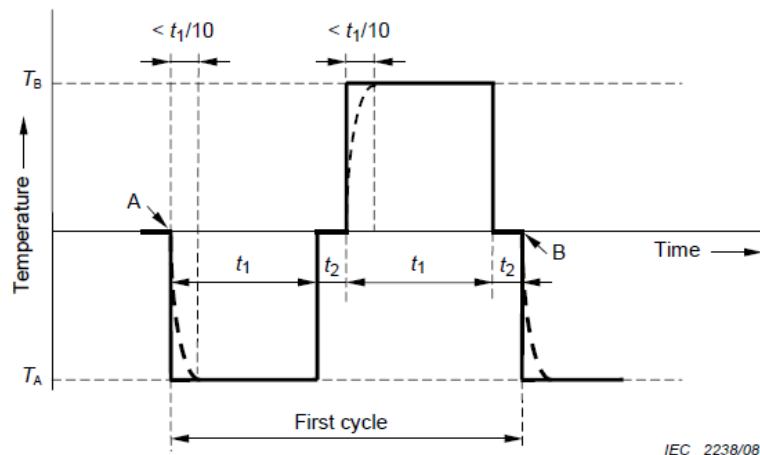

Key

- A start of first cycle
B end of first cycle and start of second cycle

NOTE The dotted curve is explained above.

Figure 2 – Na test cycle

Test condition:Low temperature T_A: -25°CHigh temperature T_B: +60°CDuration of exposure time t₁: 3hDuration of transfer time t₂: 3min

Number of cycles: 5

Recovery: 2h

Test result:

Measurements Pre-functional test:

PV Input:		AC grid output (line to neutral):	
Voltage DC (V)	597.3	Voltage AC (V)	230.4
Current DC (A)	25.7	Current AC (A)	21.8
Power DC (W)	15334	Active Power AC (W)	15055

Measurements During test:

PV Input:		AC grid output (line to neutral):	
Voltage DC (V)	597.4	Voltage AC (V)	230.4
Current DC (A)	25.7	Current AC (A)	21.8
Power DC (W)	15331	Active Power AC (W)	15052

Measurements Post-functional test:

PV Input:		AC grid output (line to neutral):	
Voltage DC (V)	596.8	Voltage AC (V)	230.4
Current DC (A)	25.7	Current AC (A)	21.8
Power DC (W)	15326	Active Power AC (W)	15050

After the test, the EUT can operation normally.

4.4 TEST DB: DAMP HEAT, CYCLIC (12 H + 12 H)

The test purpose is the determination of the suitability of components, equipment or other articles for the use, transportation and storage abnormal conditions of high humidity, combined with cyclic temperature changes and, in general, producing condensation on the surface of the specimen, according to the standard IEC 60068-2-30. Environmental testing. Part 2-30: Tests. Test Db-Variant 1: Damp heat, Cyclic (12 h + 12 h).

Test Severities

Variant 2 (see Figure 2b)

The temperature shall be lowered to $25\text{ °C} \pm 3\text{ K}$ within 3 h to 6 h, but without the additional requirement for the first hour and one half as in variant 1. The relative humidity shall be not less than 80 % RH.

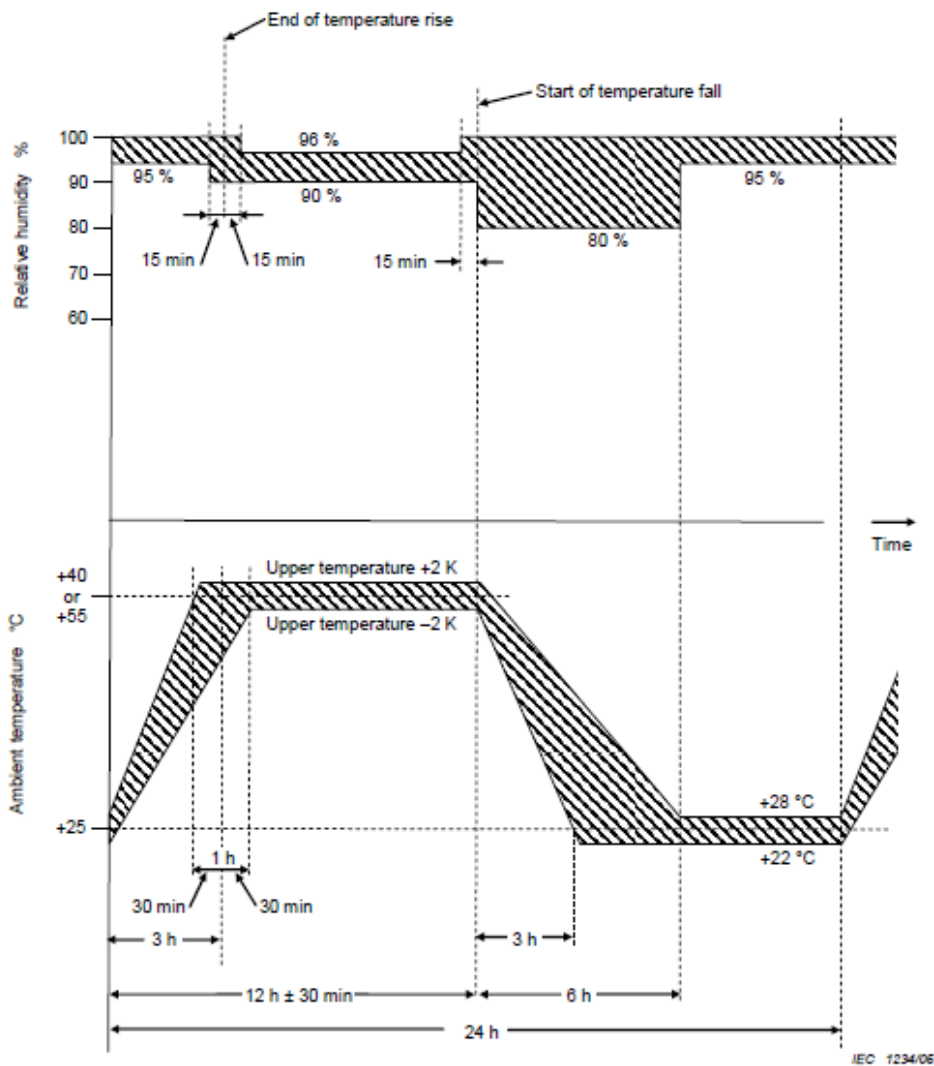

Figure 2b – Test Db – Test cycle – Variant 2

Test condition:

Test Db, variant 2, b-cycle
 The humidity level shall be 95 % \pm 5 %
 A minimum number of 3 cycles
 Lower temperature: 25°C
 Upper temperature: 55°C

Test result:

Measurements Pre-functional test:

PV Input:		AC grid output (line to neutral):	
Voltage DC (V)	597.5	Voltage AC (V)	230.4
Current DC (A)	25.7	Current AC (A)	21.8
Power DC (W)	15336	Active Power AC (W)	15051

Measurements During test:

PV Input:		AC grid output (line to neutral):	
Voltage DC (V)	597.2	Voltage AC (V)	230.0
Current DC (A)	25.7	Current AC (A)	21.8
Power DC (W)	15331	Active Power AC (W)	15047

Measurements Post-functional test:

PV Input:		AC grid output (line to neutral):	
Voltage DC (V)	597.0	Voltage AC (V)	230.0
Current DC (A)	25.7	Current AC (A)	21.8
Power DC (W)	15334	Active Power AC (W)	15045

After the test, the EUT can operation normally.

5 PICTURES

Front view



Back view



Internal View of EVVO 15000TLG23P



Internal View of Model EVVO 10000TLG23P, EVVO 12000TLG23P



EVVO 15000TLG23P INV Inductance

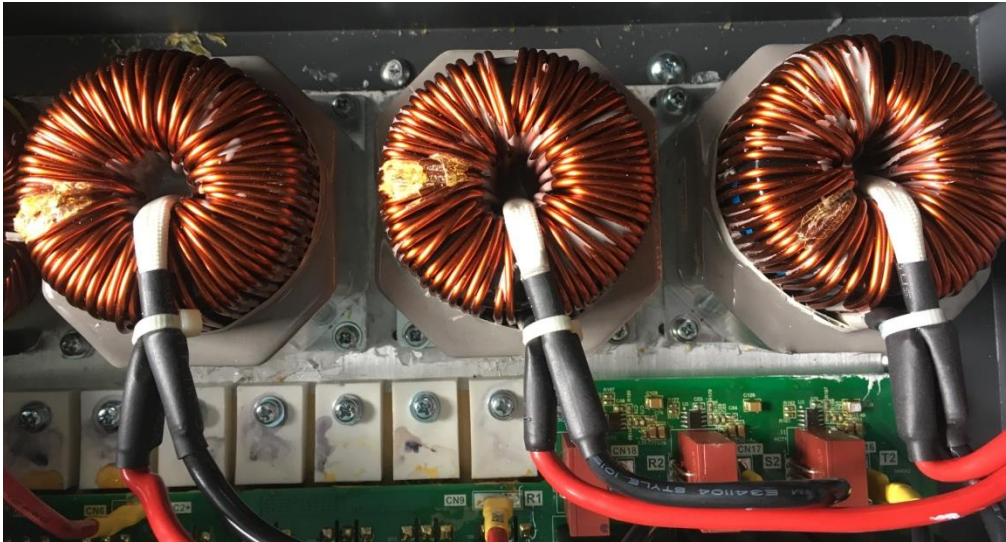

EVVO 10000TLG23P, EVVO 12000TLG23P INV Inductance

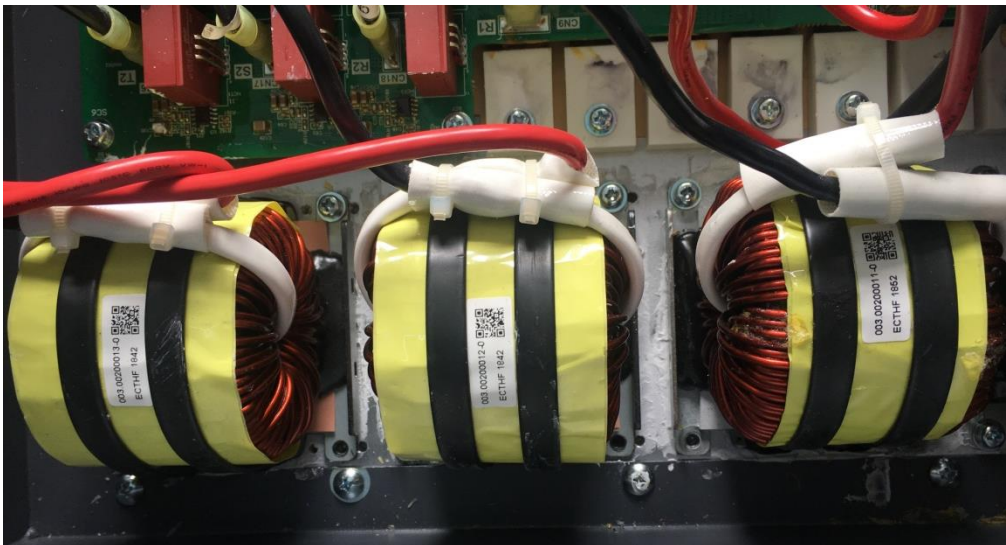

Front side of main board

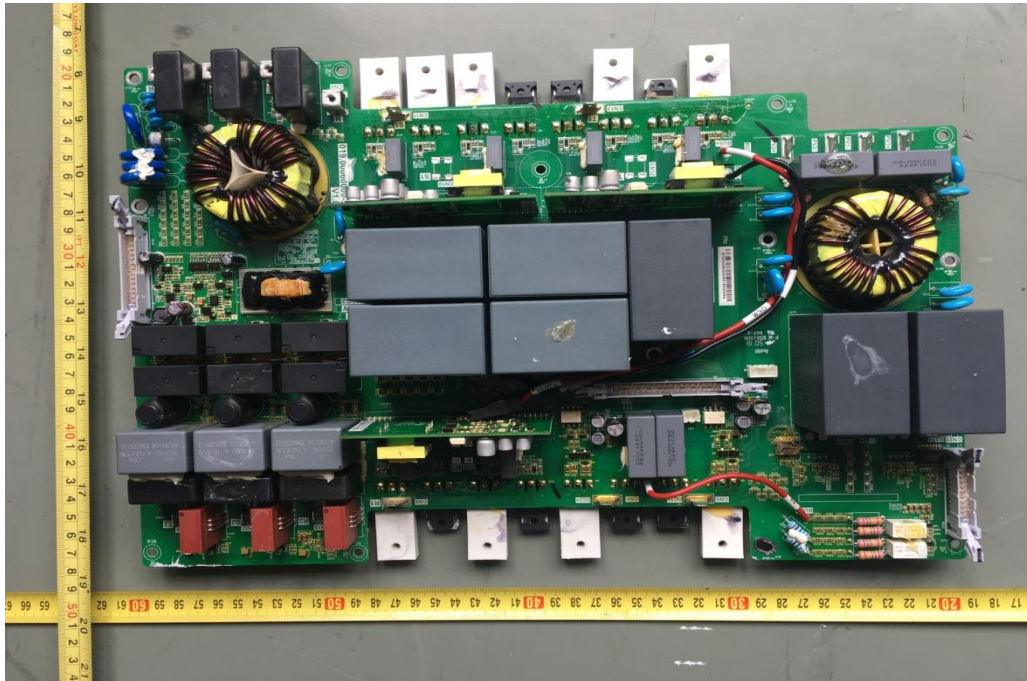

Back side of main board

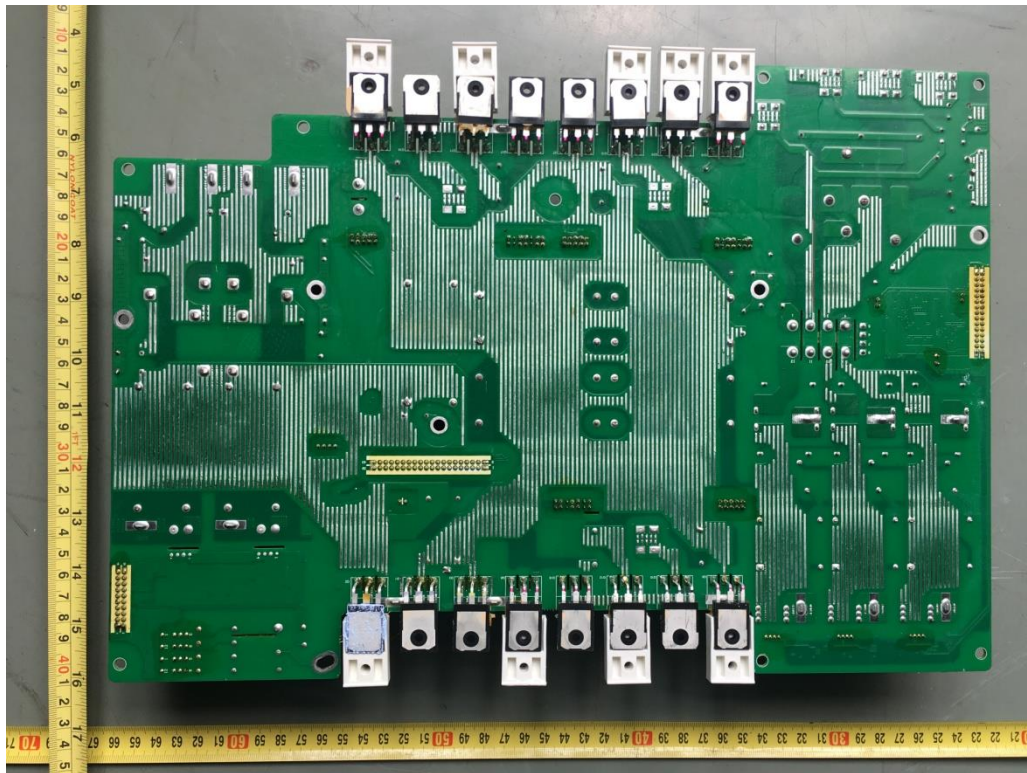

Front side of Display board

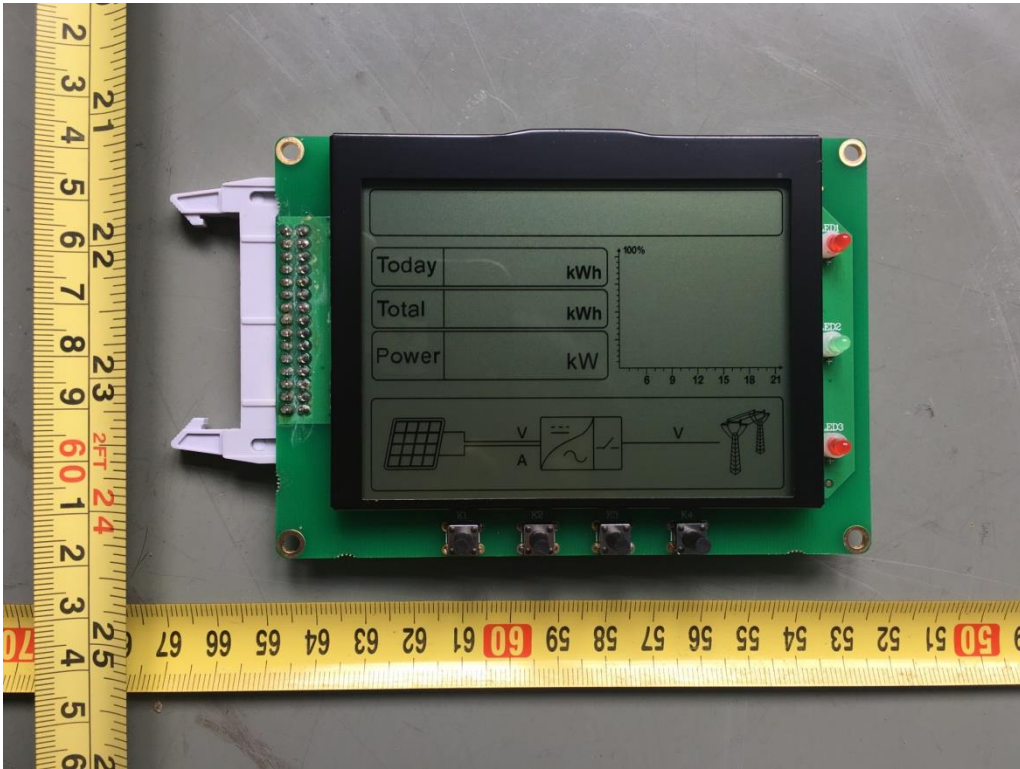

Back side of Display board

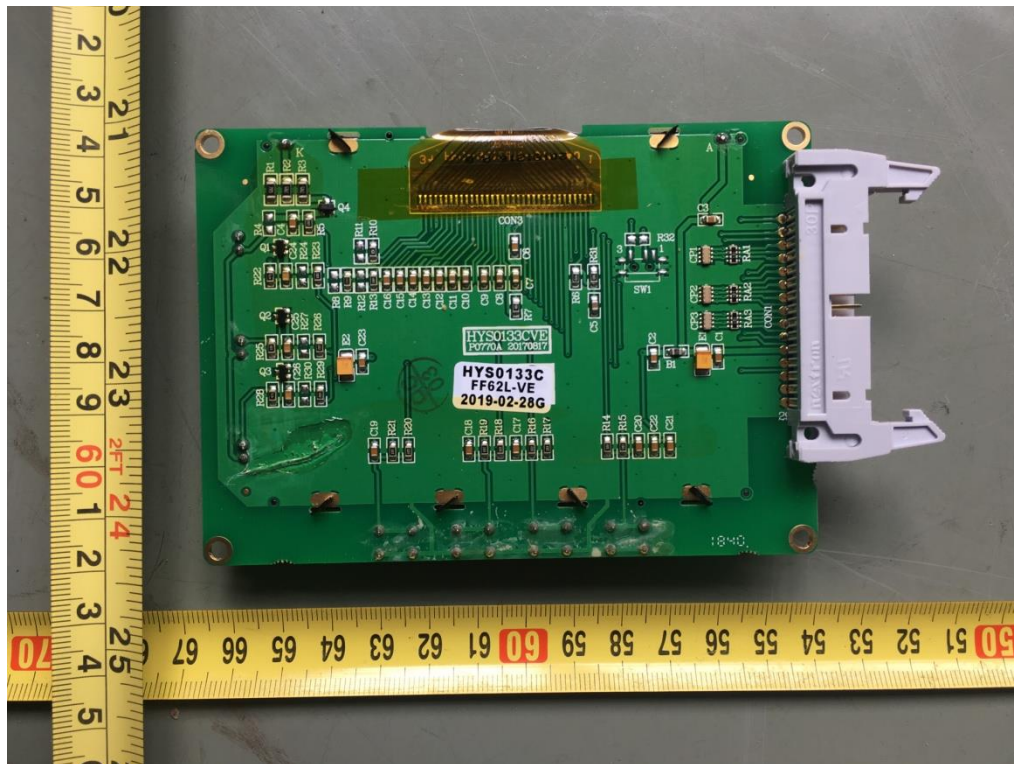

Front side of Control board

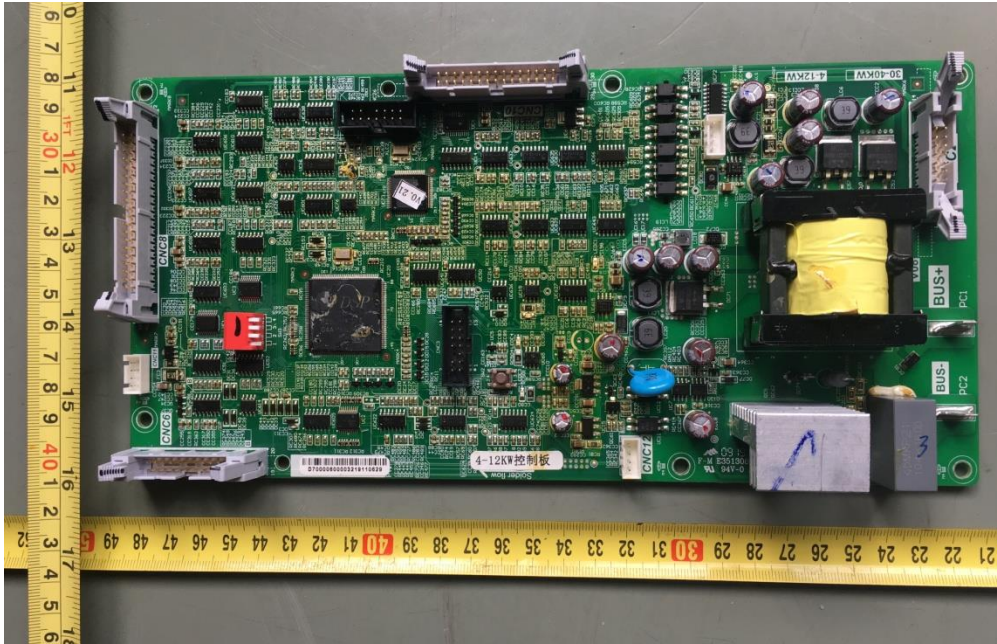

Front side of Control board

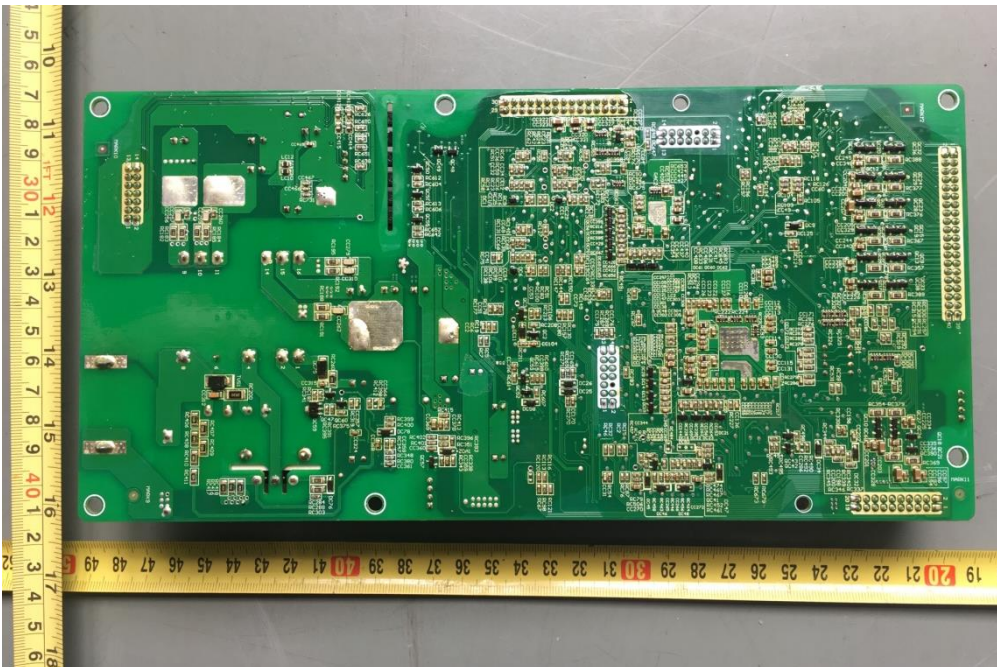

Front side of Communication board



Front side of Communication board

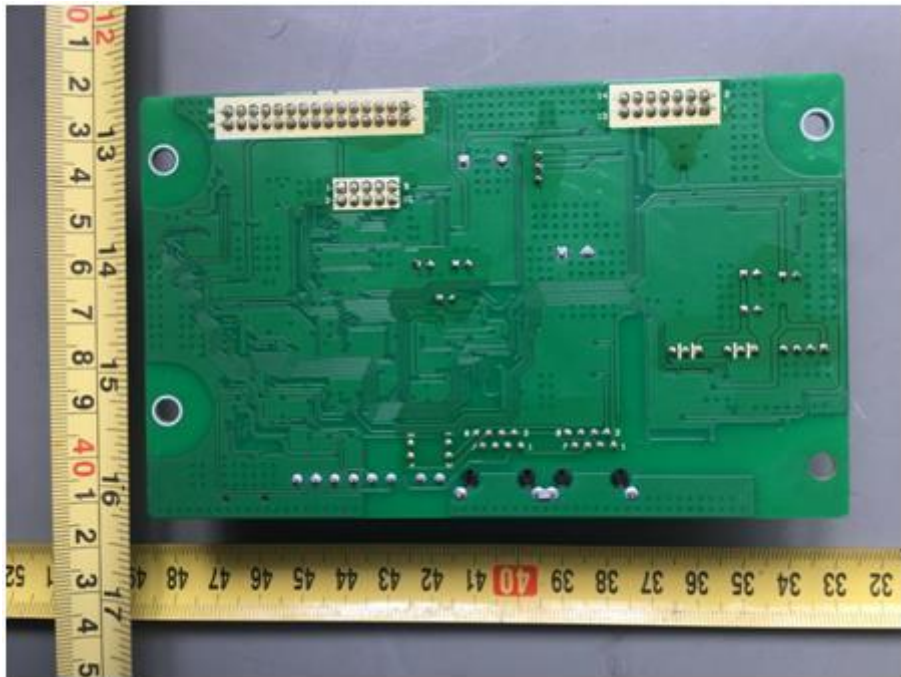

Front view of RS 232 board



Back view of RS 232 board



Grounding



Connection interface



Serial Number

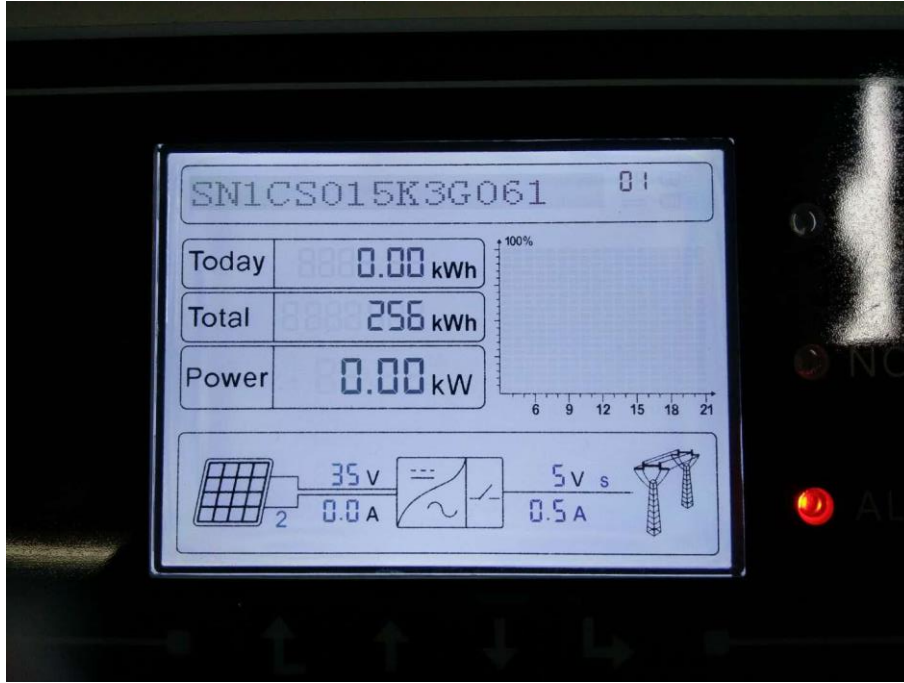

Software Version

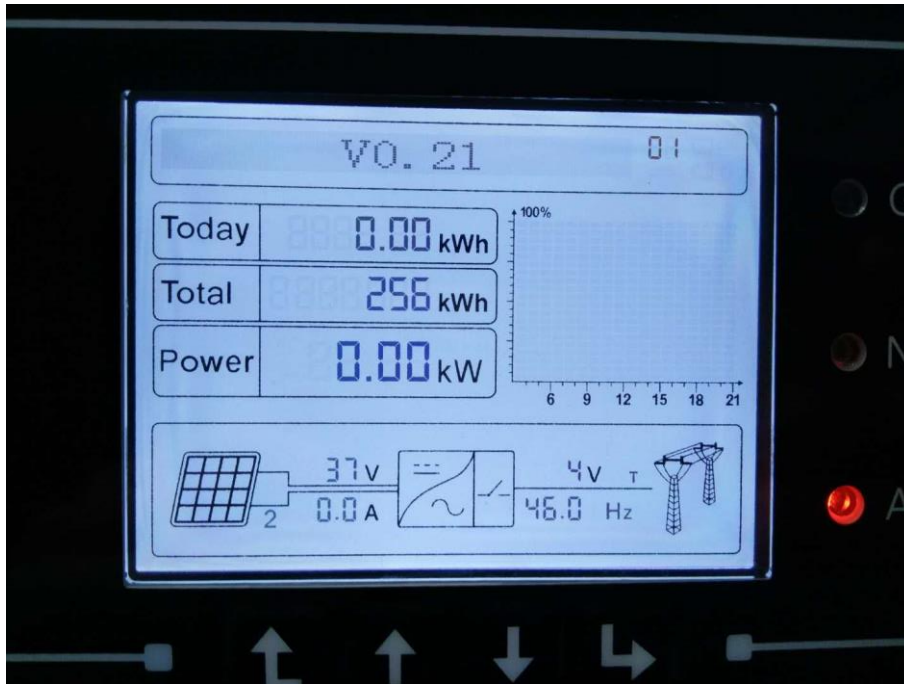

EUT Setup in Chamber

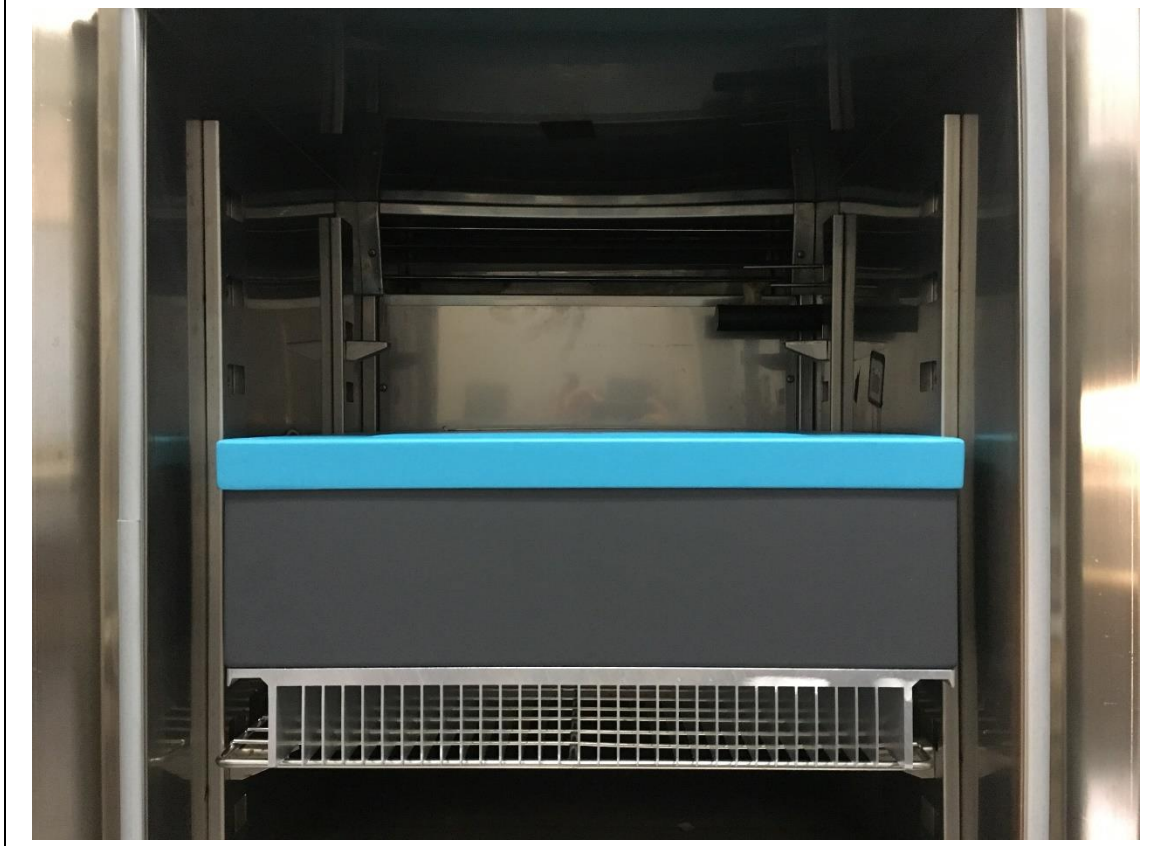

6 ELECTRICAL SCHEMES

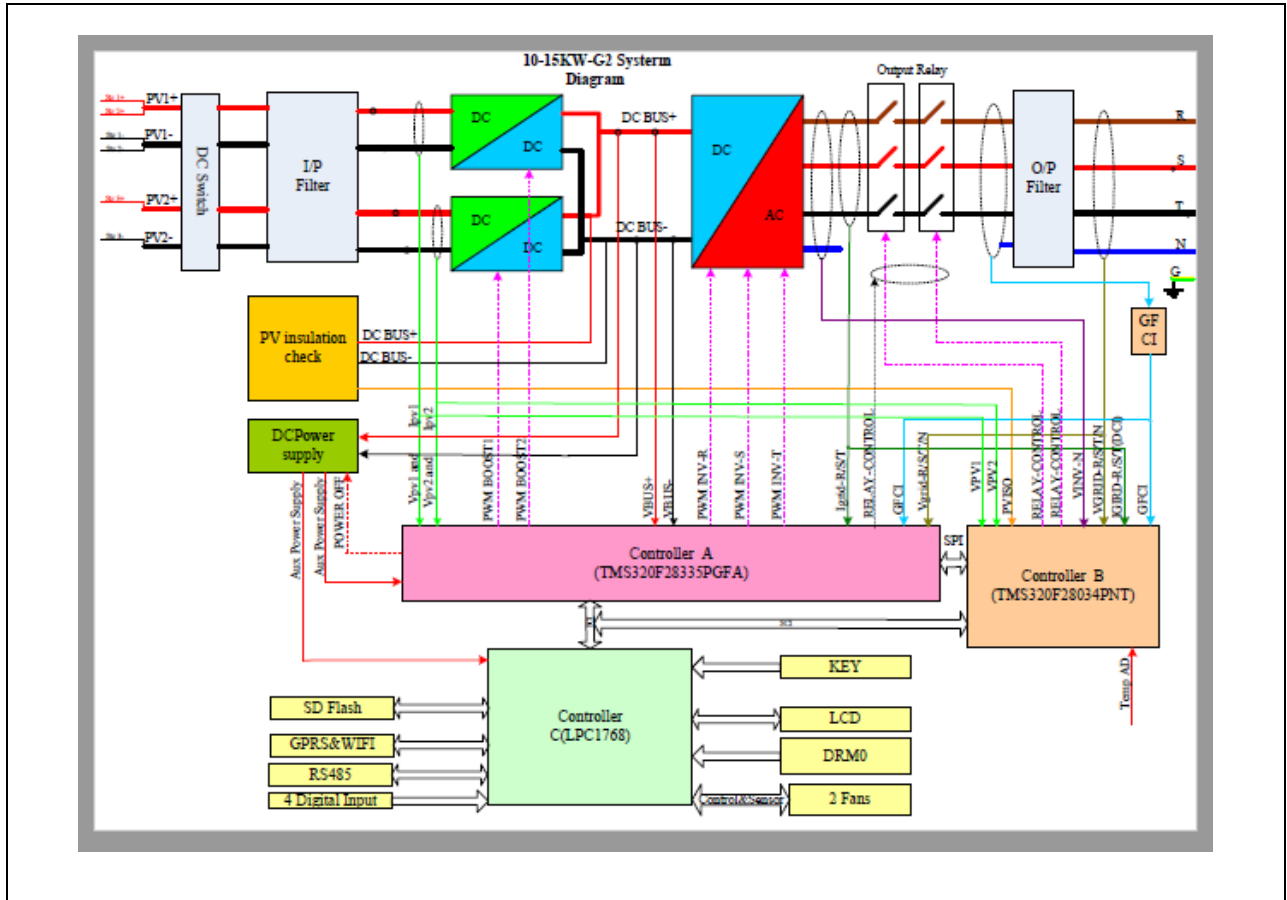

-----END OF REPORT-----